

Bingo Evolution T2 - La poussette confort évolutive

Informations générales :

Prix **Décembre 2022** en € hors TVA (6%) - franco de port

Ces prix peuvent être modifiés sans préavis - Garantie 2 ans

Profondeur d'assise 22-40 cm (XXL 45 cm) Hauteur dossier 54-75 cm (XXL 83 cm)
 Largeur d'assise 23-35 cm Longueur mollet 16-40 cm Repose pieds inclinable



Coordonnées :

Nom : _____

Adresse : _____

Date essai:

Tel : _____

Couleurs

Couleur châssis : Gris métal (002) Noir mat (032)

Couleur accessoires: Noir (346) (les pelotes latérales, cales cuisses et repose tête sont de la couleur des coussins)

Couleur coussins: Noir (346)
 Lila soft (347)
 Turquoise soft (349)
 Gris soft (348)

N° d'article		Désignation		Prix	Photo
Bingo et accessoires châssis					
3234-1000	<input type="checkbox"/>	BINGO Evolution châssis T.2 roues (avant) pivotantes	pièce	1.480	
3234-1030	<input type="checkbox"/>	BINGO Evolution Cross châssis T.2 roues (avant) pivotantes roues de 16 pouces, freins tambour inclus	pièce	1.844	
3234-2000	<input type="checkbox"/>	BINGO Evolution assise T.2	pièce	1.557	
HOG.xxl	<input type="checkbox"/>	Bingo Evolution - profondeur d'assise + 5 cm et dossier + 8 cm—noir	pièce	382	
SA-0298-MP	<input type="checkbox"/>	axe arrière renforcé (10 kg en + pour accessoires médicaux)	set	236	54
SA-0355-MP	<input type="checkbox"/>	largeur d'assise plus large de 5 cm (uniquement sur devis)	pièce	devis	
3231-7100	<input type="checkbox"/>	anti-bascule	paire	70	
1219-0004S	<input type="checkbox"/>	pneus gonflables jante noir	paire	inclus	43
1219-0030	<input type="checkbox"/>	pneus gonflables frein tambour (2 poignées - jante noir)	paire	346	44
1229-0004S	<input type="checkbox"/>	pneus pleins PU mousse jante noir	paire	inclus	45
1229-0009	<input type="checkbox"/>	pneus pleins PU mousse jante noir	paire	inclus	46
1229-0030	<input type="checkbox"/>	pneus pleins PU mousse frein tambour (2 poignées - jante noir)	paire	346	47
3202-7100	<input type="checkbox"/>	arrêt roues pivotantes	paire	116	38
3231-7201	<input type="checkbox"/>	freins par serrage externe (poignées - pas pour frein tambour)	paire	350	55
3233-9401	<input checked="" type="checkbox"/>	sac fourre-tout léger capacité 3 kg	pièce	inclus	48
3231-7300	<input type="checkbox"/>	sécurité de transport	set	218	50
3231-9500	<input type="checkbox"/>	plaque côté (couleur coussins <input type="checkbox"/> couleur châssis <input type="checkbox"/>)	set	inclus	41-42
Suspensions					
3231-1301	<input type="checkbox"/>	sans suspension	paire	inclus	
3231-7400	<input type="checkbox"/>	suspension réglable 4 positions	paire	250	
1131-9017	<input type="checkbox"/>	avec amortisseurs suspension jusque 15kg (couleur coussins <input type="checkbox"/> châssis <input type="checkbox"/>)			
1131-9018S	<input type="checkbox"/>	ou amortisseurs suspension jusque 25kg (couleur coussins <input type="checkbox"/> châssis <input type="checkbox"/>)			
1131-9019S	<input type="checkbox"/>	ou amortisseurs suspension plus de 25kg (couleur coussins <input type="checkbox"/> châssis <input type="checkbox"/>)	paire	295	
3231-7400E	<input type="checkbox"/>	suspension réglable 4 positions (montage ultérieur)			
Accessoires assise					
3234-5100	<input checked="" type="checkbox"/>	coussins d'assise T.2	pièce	inclus	
3234-5190	<input type="checkbox"/>	plaque mollet pour coussin d'assise T.2	pièce	58	4
Repose pieds					
3234-2500	<input type="checkbox"/>	support repose pied 90°	pièce	inclus	5
3234-2402	<input type="checkbox"/>	support repose pied réglable 85°-170° (UL 19cm minimum)	pièce	116	6
3231-249X	<input type="checkbox"/>	repose pieds avec rebord arrière largeur <input type="checkbox"/> 3=31 cm <input type="checkbox"/> 4=33 cm <input type="checkbox"/> 5=35 cm	pièce	inclus	7
3233-2551	<input type="checkbox"/>	repose pied avec rebord arrière et latéral largeur 35 cm	pièce	12	
3240-2950	<input type="checkbox"/>	verrouillage repose pied	pièce	134	8

Maintenance (cales - ceintures - plots)					
3233-2900	<input type="checkbox"/>	petites cales-cuisses réglables en largeur et profondeur (largeur min. 25cm)	paire	inclus	1
3233-2600	<input type="checkbox"/>	grandes cales-cuisses démontables réglables en largeur et profondeur	paire	116	2
3233-7600	<input type="checkbox"/>	petite cale tête T.2	set	226	10
3203-7600	<input type="checkbox"/>	grande cale tête T.2	set	263	11
3233-7700	<input type="checkbox"/>	cale thorax T.2 réglable en hauteur (10 X 12 X 2cm)	set	340	13
3234-7700	<input type="checkbox"/>	cale thorax T.3 réglable en hauteur (12 X 13 X 2cm)	set	340	
3231-6702	<input type="checkbox"/>	ceinture de hanche 4 points (SB 22-30)	pièce	213	15
3231-6703	<input type="checkbox"/>	ceinture de hanche 4 points (SB 28-36)	pièce	213	
3201-6100	<input type="checkbox"/>	ceinture ventrale	pièce	105	14
3201-6200	<input type="checkbox"/>	ceinture 5 points	pièce	inclus	16
3201-6300	<input type="checkbox"/>	sangles pieds	paire	47	17
3203-6400	<input type="checkbox"/>	sangles chevilles T.2	paire	200	18
3233-5300	<input type="checkbox"/>	ceinture d'abduction T.2	pièce	163	19
3201-5500	<input type="checkbox"/>	veste de maintien T.2	pièce	163	20
3203-5400	<input type="checkbox"/>	veste de maintien T.3	pièce	174	
3201-5700	<input type="checkbox"/>	harnais poitrine T.2	pièce	152	21
3203-5600	<input type="checkbox"/>	harnais poitrine T.3	pièce	158	
3231-7900	<input type="checkbox"/>	plot d'abduction T.2 escamotable	pièce	234	22
3231-7901	<input type="checkbox"/>	plot d'abduction T.2 fixe	pièce	133	23
3233-7800	<input type="checkbox"/>	plot d'abduction T.3 escamotable	pièce	252	
3233-7801	<input type="checkbox"/>	plot d'abduction T.3 fixe	pièce	134	
SA-0311-MP	<input type="checkbox"/>	réglage en profondeur (40mm) plot d'abduction T2 & T3 (suppl)	pièce	58	
Accessoires					
3232-2203	<input type="checkbox"/>	fixation accessoire (obligatoire pour table ou barre de protection)	set	53	24
3233-8100	<input type="checkbox"/>	barre de protection avec rembourrage T.2	pièce	105	25
3233-8200	<input type="checkbox"/>	table thérapeutique transparente T.2 (*1, *2)	pièce	419	26
3233-8202	<input type="checkbox"/>	table thérapeutique transparente T.2 réglable en hauteur (*1)	pièce	487	27
3233-8201	<input type="checkbox"/>	table thérapeutique grise T.2 (*1, *2)	pièce	299	
3233-8203	<input type="checkbox"/>	table thérapeutique grise T.2 réglable en hauteur (*1)	pièce	365	
		*1 uniquement assise sens de la marche, *2 pas avec grandes cales-cuisses			
3201-8400	<input type="checkbox"/>	sac hiver T.2 (*3)	pièce	331	28
3203-8300	<input type="checkbox"/>	sac hiver T.3 (*3)	pièce	349	
7000-0019	<input type="checkbox"/>	insert peau de mouton T.2 (*3)	pièce	265	29
7000-0020	<input type="checkbox"/>	insert peau de mouton T.3 (*3)	pièce	291	
		*3 si plot d'abduction, uniquement compatible avec plot amovible			
3203-9200	<input type="checkbox"/>	protection pluie T.2 (sorte de poncho)	pièce	69	30
3201-9300	<input type="checkbox"/>	capote pluie avec protection	set	283	31
3231-3001	<input type="checkbox"/>	support coque à monter sur châssis	set	810	
7000-0010	<input type="checkbox"/>	buggy board	set	158	51
7000-0012	<input type="checkbox"/>	parasol « ninaclip »	set	58	52
7000-0058	<input type="checkbox"/>	sac accessoires + coussin à langer (noir)	set	179	53

ACCESSOIRES BINGO EVOLUTION

01



02

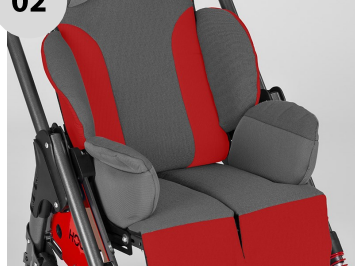

04



05



06



07



08



10



11



13

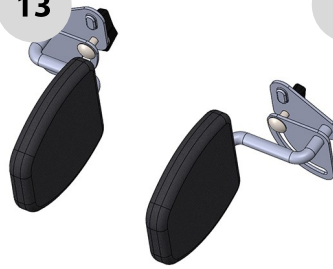

14



15

16



17



18



19



20



21



22

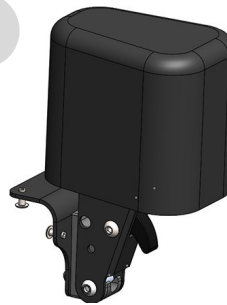

23



24

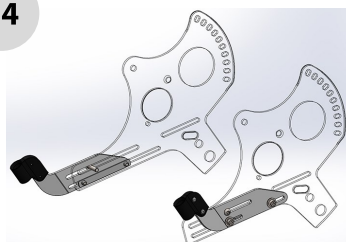

25



26

OU

27

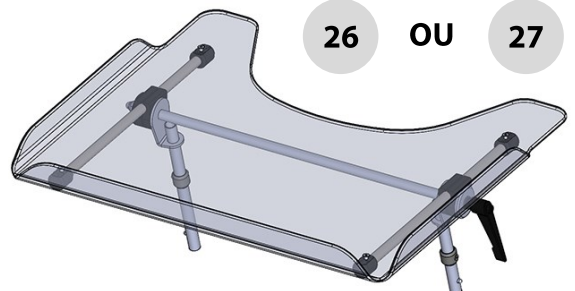

ACCESSOIRES BINGO EVOLUTION

28



29



30



31



38



41



42



43



44



45



46



47



ACCESSOIRES BINGO EVOLUTION

48



49



50

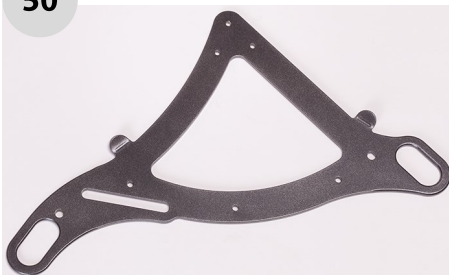

51



52



53



54

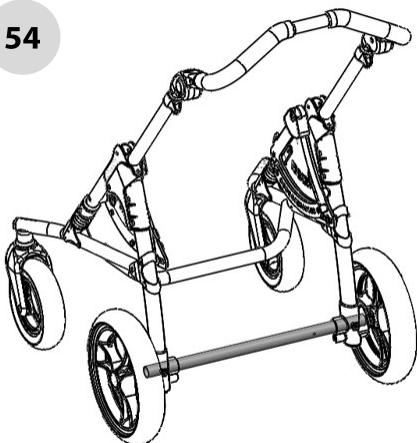

55



I- COULEUR DU CHÂSSIS



Noir mat
(032)

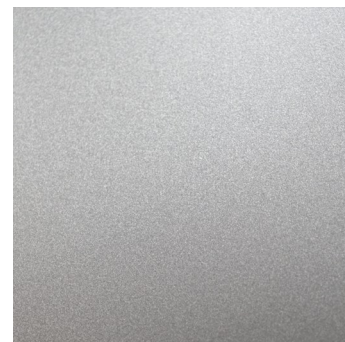

Gris métallisé
(002)



Une seule couleur de
châssis au choix

IIa- COULEUR DU COUSSIN UNICOLORE



Rose pastel
(347)

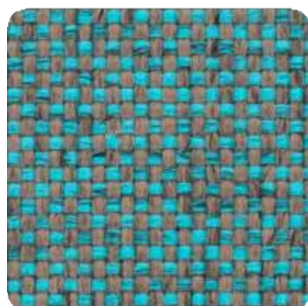

Turquoise pastel
(349)

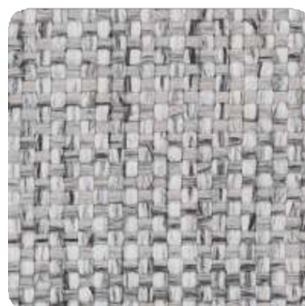

Gris pastel
(348)



Noir

DIFFÉRENTES VARIANTES CHÂSSIS NOIR



DIFFÉRENTES VARIANTES CHÂSSIS GRIS



IIB- COULEUR DU COUSSIN BICOLORE BINGO EVOLUTION



III- COULEUR DE LA PLAQUE DE CÔTÉ BINGO EVOLUTION

Couleur châssis	Noir mat (032)	Gris métallisé (002)
Couleur coussin—unicolore		
Rose pastel (347)	Plaque rose ou noire	Plaque rose ou grise
Turquoise pastel (349)	Plaque turquoise ou noire	Plaque turquoise ou grise
Gris pastel (348)	Plaque grise ou noire	Plaque grise
Noir (346)	Plaque noire	Plaque noire ou grise
Couleur coussin bicolore		
Rose pastel / Noir	Plaque rose ou noire	Plaque rose ou grise
Turquoise pastel / Noir	Plaque turquoise ou noire	Plaque turquoise ou grise
Gris pastel / Noir	Plaque grise ou noire	Plaque grise

IV- COULEUR DES RESSORTS BINGO EVOLUTION

Couleur châssis	Noir mat (032)	Gris métallisé (002)
Couleur coussin—unicolore		
Rose pastel (347)	Ressort rose ou noir	Ressort rose ou gris
Turquoise pastel (349)	Ressort turquoise ou noir	Ressort turquoise ou gris
Gris pastel (348)	Ressort gris ou noir	Ressort gris
Noir (346)	Ressort noir	Ressort noir ou gris
Couleur coussin bicolore		
Rose pastel / Noir	Ressort rose ou noir	Ressort rose ou gris
Turquoise pastel / Noir	Ressort turquoise ou noir	Ressort turquoise ou gris
Gris pastel / Noir	Ressort gris ou noir	Ressort gris



Rose pastel



Turquoise pastel



Gris pastel



Noir